



# LanXPLOER



## **COPYRIGHT NOTICE**

The information contained in this document is the property of TREND NETWORKS and is supplied without liability for errors and omissions. No part of this document may be reproduced or used except as authorized by contract or other written permission from TREND NETWORKS. The copyright and all restrictions on reproduction and use apply to all media in which this information may be placed.

TREND NETWORKS pursues a policy of continual product improvement and reserves the right to alter without notice the specification, design, price or conditions of supply of any product or service.

## **© TREND NETWORKS 2021**

All rights reserved  
Publication ref: 150835 Issue 5  
Issue 5 - 03/21  
Applies to software revision 2.0.0 onwards

TREND NETWORKS  
Stokenchurch House  
Oxford Road  
Stokenchurch  
High Wycombe  
Buckinghamshire  
HP14 3SX UK

[www.trend-networks.com](http://www.trend-networks.com)

## Safety precautions

### Caution on handling rechargeable batteries (accumulator batteries)

All nickel/metal hydride (Ni-MH) rechargeable batteries generate sufficient electrical current to cause injury and/or damage regardless of the charge state indicated.

Nickel/metal hydride (Ni-MH) rechargeable batteries should never be exposed to fire or disposed of with normal domestic waste. Nickel/metal hydride (Ni-MH) rechargeable batteries can explode when exposed to open flames. These batteries constitute special hazardous waste and can contaminate the ground water when disposed of at a waste dump.

Observe the following instructions precisely when handling rechargeable batteries to avoid injury.

- When a rechargeable battery is not installed in the hand-held instrument, it should be stored in a clean, dry and non-conductive package.
- Ensure that the contacts on the rechargeable battery do not come into contact with conductive materials.
- Avoid touching the contact surfaces on the rechargeable battery.
- The rechargeable batteries can be charged while installed in the hand-held instrument. Charging in any other manner can result in the rechargeable battery exploding.
- Install, remove, store and charge the rechargeable batteries only in non-explosive atmospheres.
- Observe the operating and storage temperatures (see Chapter 1.2. Dimensions, Weights, Operating Conditions).
- Do not allow children or persons not familiar with the safety precautions in these operating instructions to handle or charge rechargeable batteries.
- Never open the rechargeable battery case. There are no user-serviceable parts in the case and the rechargeable batteries contained in the case are not replaceable.

## Disclaimer

TREND NETWORKS assumes no liability for death, injury, or damage to equipment or property resulting from improper use of the rechargeable batteries.

TREND NETWORKS assumes no liability for subsequent damage resulting from modifications to the rechargeable batteries or the charger or use of the same.

All rights to technical modification reserved.

## Environmental Protection

Please contact a representative of TREND NETWORKS if you have any questions regarding safe handling and disposal of the rechargeable batteries used in the LanXPLOER. Contact information is given in the Chapter *Customer Service*.

## Working with the LanXPLOER

The factory settings on the LanXPLOER are based on general standards, recommended industrial standards for cable and network links, state-of-the-art technical information from the international committees for LAN cable standards, the LAN industry as well as values gained from tests and experience of TREND NETWORKS

Before performing any measurements TREND NETWORKS recommends clarifying with the principal or project manager, precisely which measurements are to be performed to ensure that all relevant parameters are maintained.

## Notes on use of these operating instructions

The following symbols used in these operating instructions indicate that the user should proceed with particular care to prevent injuries to humans, damage to the LanXPLOER or to the system to be tested.



**ATTENTION!**

This symbol indicates potential lethal voltages. This poses a hazard for the life and/or health of the person performing the action or any other humans in the vicinity.



**CAUTION!**

This symbol indicates that the action in question may pose a hazard for the environment or damage technical equipment.

**NOTE:**

General notes, additional information or assistance are given here.

## Typographic conventions

**Bold face**

Indicates a key on the LanXPLOER.

*Italics*

Indicates a menu option in these operating instructions.

Quotation marks " "

Indicate a "Screen message"

Asterix \*

Indicates a module-related option



Indicates a softkey

# CONTENTS

Chapter 1	Your LanXPLOER	6
Chapter 2	Instrument Description	9
Chapter 3	Settings	15
Chapter 4	Test Summary	34
Chapter 5	Test Setup	35
Chapter 6	Test Description and Procedure	41
Chapter 7	Wiring test on fibre-optic conductors and SFP modules	56
Chapter 8	LanXPLOER firmware update	57
Chapter 9	Spare parts - Socket inserts	58

The LanXPLOER can be used to test RJ45 cable routes, networks, connected Ethernet devices and fibre-optic cable used for high speed transmission of data in communications networks.

### 1.1. Technical Data

Function	LanXPLOER	LanXPLOER PLUS	LanXPLOER PRO
Screen size	3.5" TFT colour	3.5" TFT colour	3.5" TFT colour, TOUCH
Wiremap	✓	✓	✓
Number of ports	1 copper	1 copper 1 WiFi	2 copper 1 fibre, WiFi
Tone Generator	✓	✓	✓
PoE / PoE+ measurement	✓	✓	✓
PoE / PoE+ device load measurement			✓
Basic active tests (DHCP, Ping etc.)	✓	✓	✓
Top Ten test (Talkers, Listeners, protocols etc.)	✓	✓	✓
Device map / Netverify	✓	✓	✓
Inline testing			✓
VoIP measurement			✓
VLAN Discovery	✓	✓	✓
802.1x	✓	✓	✓
Loopback			✓
Results transfer to PC	Via USB memory stick	Via USB memory stick	Via USB memory stick
Internal battery charging	✓	✓	✓
External power supply	✓	✓	✓

**Maintenance of test standards:**

ANSI/TIA/EIA 568A, 568B

**Types of cable**

Wiring in compliance with UTP/SCTP/FTP CAT 3/5e/6<sub>A</sub>/7 (100 Ω)

**1.2. Dimensions, Weights, Operating Conditions**

**Dimensions:**

(L) 205 mm x (W) 98 mm x (D) 45 mm

**Weights:**

Handheld display      650 g (incl. Batteries)

Batteries                180 g

**Batteries:**

AA Alkaline

NiMH<sup>i</sup>\* (battery pack)

**Operating time with rechargeable batteries:**

4 hours under normal operating conditions

**Charging time:**

In instrument 8 hours

**Operating temperature (min./max.):**

0° C to +40° C (use only when instrument temperature is close to ambient temperature!)

**Storage temperature (min./max.):**

-20° C to +70° C

**Relative humidity:**

5% to 90%, non-condensing

### 1.3. Equipment included Basic version

Quantity	Description
1	Measuring instrument
1	Active Remote
1	Carrying case
2	STP Patch cables, 30 cm
1	CD with operating instructions
1	Brief instructions
6	AA Alkaline batteries



## 2.1. LanXPLOER

The LanXPLOER guarantees control of the settings and test functions while performing individual tests.

### 2.1.1. Controls and Interfaces/Connections

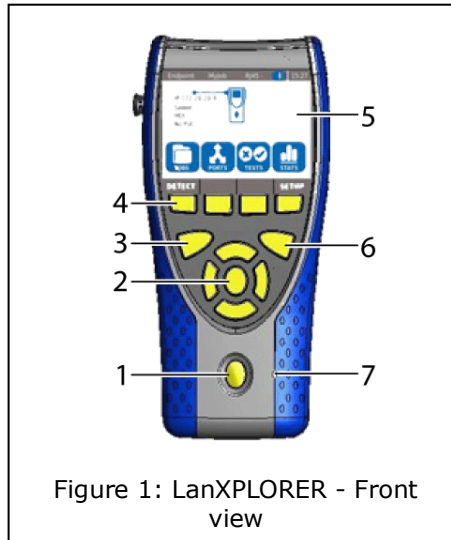

Figure 1: LanXPLOER - Front view

Item	Controls	Description
1	<b>ON/OFF</b>	For switching the LanXPLOER on and off. Hold key down: To restart.
2	<b>Arrow keys / Enter</b>	For navigation in menus on TFT display / Entry key for activation and editing in selected menu.
3	<b>Autotest</b>	Immediate execution of pre-programmed test procedure.
4	<b>Function keys F1 to F4</b>	For selection of softkeys displayed on screen.
5	TFT display	Display of menus, test results, graphs, actions selected and function keys. Touchscreen* for display and selection of of menus, test results, graphs, action selection and function keys.
6	<b>Escape</b>	Return to previous menu or discontinue and exit current menu without saving changes.
7	LEDs	Display of charging status Illuminated green: Batteries are being charged. Off (with charger connected): Batteries are charged. Flashing green: Batteries cannot be charged - AA cells are fitted, battery is too hot or too cold. Flashing red: Batteries cannot be charged - temperature is too high.

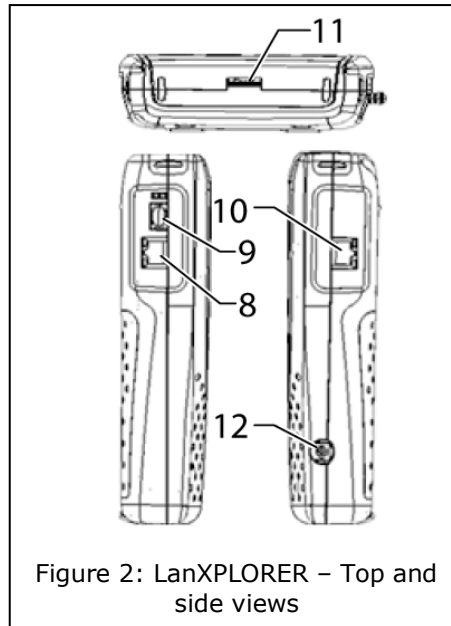

Figure 2: LanXPLOER – Top and side views

Item	Interfaces / Connections	Description
8	RJ45 1 network interface	Terminal for copper cables.
9	Fibre-optic network port	Terminal for fibre-optic cables.
10	RJ45 2 diagnostic port	Inline interface for copper cables (active devices)
11	USB external memory port	Port for connecting USB storage device.
12	Power socket	Socket for power pack

### 2.1.2. Image on TFT display

The standby screen appears when the LanXPLOER is ready for operation.

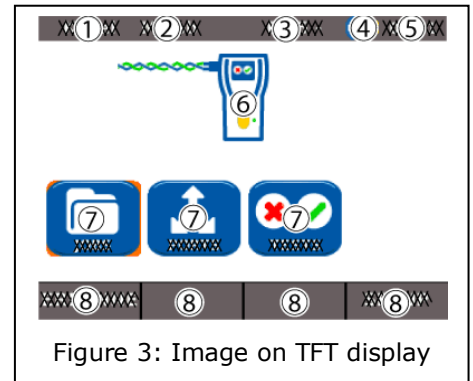

Figure 3: Image on TFT display

Item	Image	Description
1	Instrument mode	Indicates mode to which instrument is set.
2	Jobname	Indicates job in which project is being processed.
3	Physical test medium	Indicates test medium connected to LanXPLOER
4	Battery charge	Indicates battery operation or external power supply and charge state of rechargeable battery.
5	Time	
6	LanXPLOER	
7	Menu points	
8	Softkeys	

### 2.1.3. Touchscreen\*

Possible options in menus are indicated by symbols on the display. Simply touch the symbol to select the option indicated.

### 2.1.4. Arrow keys / Enter

Possible options in menus are indicated by symbols on the display. The options can be selected by moving to the corresponding symbols with the **arrow keys**. Confirm the selection by pressing the **Enter key**

### 2.1.5. Softkey

Possible options in menus are indicated by softkeys at the bottom of the screen. The **Function keys (F1 - F4)** below the softkeys can be used to select options.

The example shows optional selection of the **Setup** softkey with the softkeys at the bottom of the screen. Selection can be accomplished with **Function key F4**.

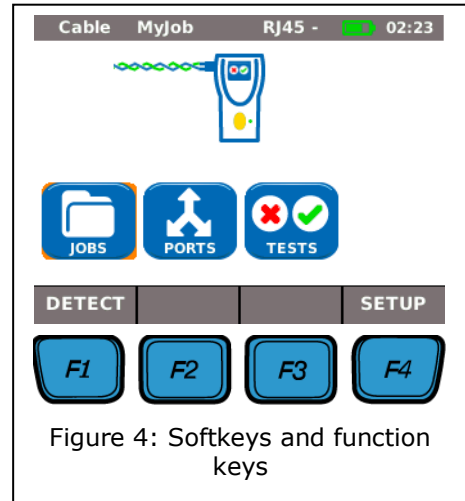

## 2.2. Power options

The LanXPLOER can be operated with replaceable AA alkaline batteries as well as rechargeable AA batteries or with an NiMH rechargeable battery pack.

- The LanXPLOER can operate for approx. 4 hours with the rechargeable batteries. The actual operating time in battery mode depends on various factors such as use of the background lighting and ambient temperature.
- If the rechargeable battery charge level drops to below the required voltage, a warning message appears. The instrument switches off automatically before any negative effects occur for the test results.
- To preserve your rechargeable batteries, it is possible to set the LanXPLOER to switch off automatically after a certain time with no activity (see settings 3.2.2).
- To increase the service life of your rechargeable batteries we recommend removing the batteries when the instrument is not used for longer periods of time.

### 2.2.1. Mains Operation

The LanXPLOER can be operated using an external DC power source (AC/DC power pack).

During operation of the instrument with the AC/DC charger/power pack, note that:

- The battery pack in the instrument is trickle charged;
- A mains plug is shown in the upper right-hand area on the LanXPLOER;
- Rechargeable AA batteries are not charged in the instrument.



#### **CAUTION!**

**Use only the power pack supplied with the instrument. Other power packs can damage the tester.**

#### **NOTE:**

**When testing shielded cables do not connect mains power, because otherwise a short-circuit to earth could occur leading to output of warnings for protection of the tester input.**

### 2.2.2. Charging rechargeable batteries

#### **NOTE:**

**The charging time depends on the charge level of the batteries.**

#### **Battery pack**

The battery pack for the LanXPLOER can be charged in the LanXPLOER using the charger/power pack. A time of approximately 8 hours is required to completely charge the battery pack in the instrument.

#### **Rechargeable AA batteries**

It is necessary to charge rechargeable AA batteries externally with a charger. They cannot be charged in the LanXPLOER.

### 2.2.3. Removing / installing rechargeable batteries

When the batteries are removed the LanXPLOERER saves the data and settings in the battery-buffered flash ROM.

1. Open the kick stand.
2. Remove the battery cover.

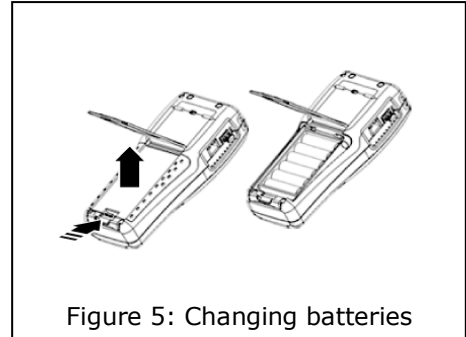

#### CAUTION!

The battery pack or battery holder is connected to the LanXPLOERER with a cable. When removing the batteries, do not pull on the cable - damage to instrument and connector could occur.

3. Remove the battery pack or battery holder.
4. Detach the connector for the battery pack or battery holder from the instrument.
5. If applicable, remove the batteries from the battery holder.

Install batteries in opposite order.

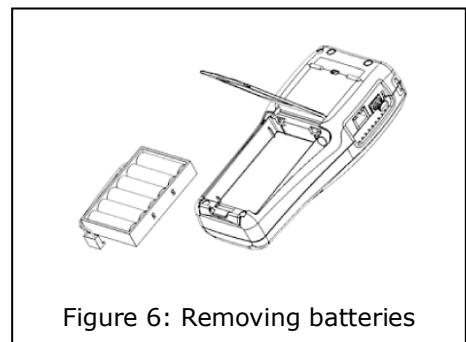

### 3.1. Principles

All instrument settings can be made with the **Setup** menu on the standby screen. Over the **Setup** menu it is possible to navigate to any of the submenus to make settings there.

1. Select the menu point **Setup**.

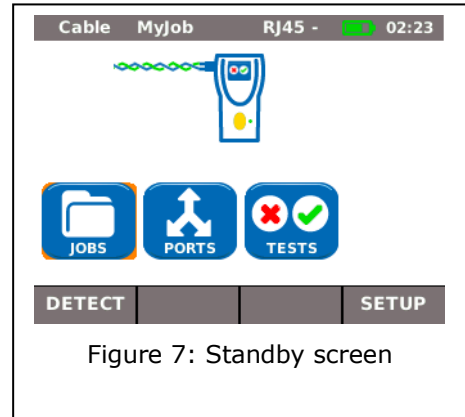

Figure 7: Standby screen

2. Make the settings by selecting the applicable menu point.

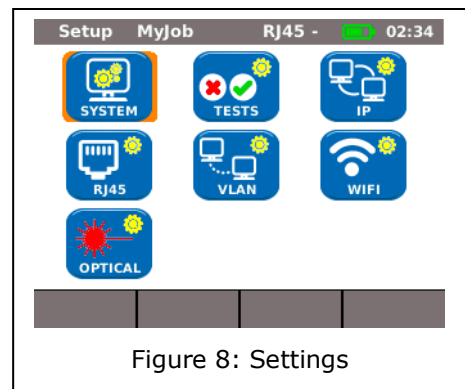

Figure 8: Settings

### 3.2. System

Instrument management is possible in the "System" menu.

1. Select the menu point "System".
2. Make the settings by selecting the applicable menu point.

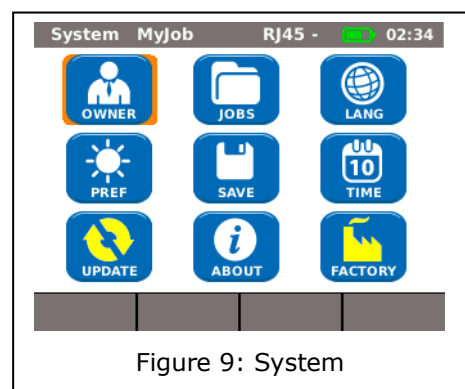

Figure 9: System

### 3.2.1. Owner

This menu allows information to be saved on the technician performing the work, the company and the client.

1. Select the menu point "Owner".
2. Select the desired option.
3. Enter the desired information with the alphanumeric keys.
4. Save the entry made with **OK**. You can exit the menu without saving the changes with **Cancel** or **Escape**.
5. Save the entry made with **Apply**. You can exit the menu without saving the changes with **Escape**.

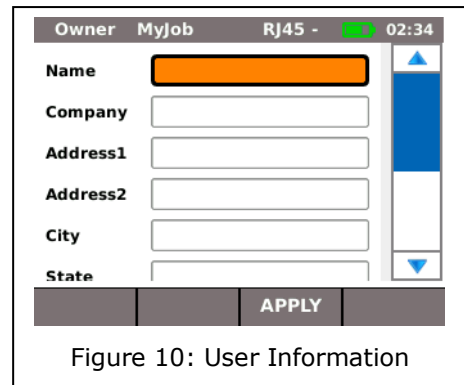

Figure 10: User Information

### 3.2.2. Preferences

This menu allows settings to be made for the display and display format.

#### Display settings

1. Select the menu point "Pref".
2. Select the desired option.
3. Set the desired option.
4. Save the entry made with **Apply**. You can exit the menu without saving the changes with **Escape**.

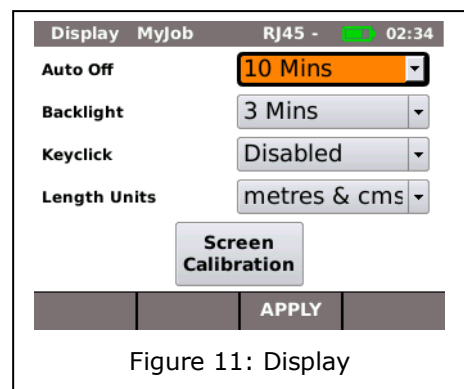

Figure 11: Display

Image	Description
<i>Auto Off</i>	Defines the time after which the LanXPLORER will shut off automatically, if not in use.
<i>Backlight</i>	Defines the time after which the back light dims automatically.
<i>Keyclick</i>	Activates/deactivates an acoustic signal when selecting menus and options.
<i>Length Units</i>	Definition of units of measure for length measurement in <i>ft</i> or <i>m</i> (feet or meters). The default setting depends on the language set.
<i>Screen Calibration*</i>	Calibration of touchscreen.



### Screen calibration\*

1. Select the menu point "Screen Calibration".
2. After the LanXPLOER has automatically restarted touch the cross-hairs, which appear one after another in each corner and in the middle of the screen, as precisely as possible with the pointer or a thin pin.

Successful calibration of the screen is confirmed by a check mark. The LanXPLOER restarts automatically after screen calibration.

### 3.2.3. Update

The LanXPLOER software can be updated with this menu (see CHAPTER 8).

### 3.2.4. Jobs

Projects can be created and managed with this menu.

**NOTE:**

Job management can also be selected directly with the menu point "Jobs" on the standby screen.

The name of the current job directory is shown on the standby screen on the TFT display. When storing the Autotest it is possible to keep this job directory, activate a job directory already present or to create a new job directory.

1. Select the menu point "Jobs" to obtain a list of all jobs created on your LanXPLOER.

### Viewing a present job and test details

1. Select a job from the list, to view the test results and their status.
2. Select a test to obtain further details on the test.
3. Select a single test to obtain further details on the test.

### Creating a new job

1. Select **Options**.
2. Select the menu point "New".
3. Select the individual fields and enter the desired information with the alphanumeric keys.
4. Save the entry made with **OK**. You can exit the menu without saving the changes with **Cancel** or **Escape**.
5. Save the entry made with **Apply**. You can exit the menu without saving the changes with **Cancel**.

### Changing a job already present

1. Select the job you want to change.
2. Select **Options**.

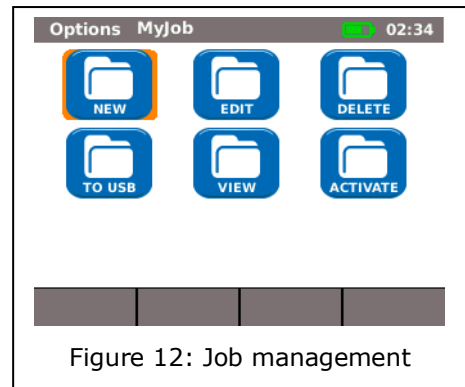

Figure 12: Job management

Menu point	Description
New	Create new job.
To USB	Save job on a USB storage device.
Edit	Change job information.
View	View jobs
Delete	Delete a job.
Activate	Activate a current job for editing.

### 3.2.5. Save

This menu allows you to

- export the current LanXPLOER configuration to a USB storage device;
- load a configuration stored on a USM storage device on the LanXPLOER.

**NOTE:**

**Data export and data import is accomplished exclusively to/from a USB storage device connected to the LanXPLOER.**

1. Select the menu point "Save".
2. Select **Save** to store the LanXPLOER configuration on a USB storage device.
3. Select **Load** to load a configuration from a USB storage device on the LanXPLOER.

The exported file is saved on the USB storage device under the Name nmmcfg.xml. to load a configuration on the LanXPLOER, it is necessary for the file with the same name to be present on the USB storage device.



Figure 13: Exporting and importing jobs

### 3.2.6. About

This menu contains information on your LanXPLOER.

1. Select the menu point "About".

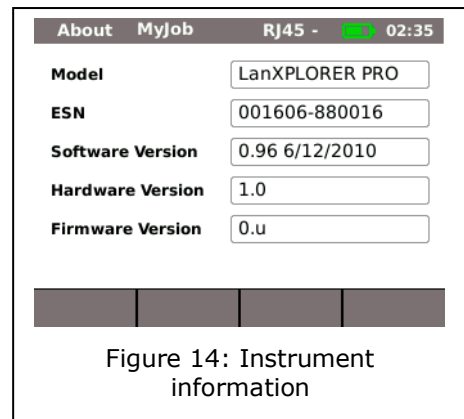

Figure 14: Instrument information

### 3.2.7. Language

The language can be set with this menu.

1. Select the menu point "Lang".
2. Select the desired language in the Option menu.
3. Save the entry made with **Apply**. You can exit the menu without saving the changes with **Escape**.

### 3.2.8. Date and Time

Correct setting of the date and time is important for reliable identification of the data records and test logs.

1. Select the menu point "Time".
2. Set the current date by selecting the month, year and day.
3. Set the current time by selecting the hour, minute and seconds.
4. Save the entry made with **Apply**. You can exit the menu without saving the changes with **Escape**.

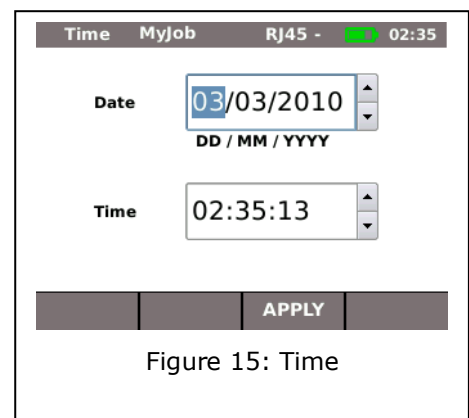

Figure 15: Time

### 3.2.9. Factory

You can set the LanXPLOER back to the factory settings with this menu.

- All settings are set back to the factory settings.
- All data is deleted from the memory.



**CAUTION!**

The data cannot be restored after deleting with the "Reset" menu. All tests stored previously are deleted irrevocably.

1. Select the menu point "Factory".
2. With **Reset** returns the instrument to the factory settings and any settings you have made are deleted.
3. You can exit the menu without saving the changes with **Cancel** or **Escape**.

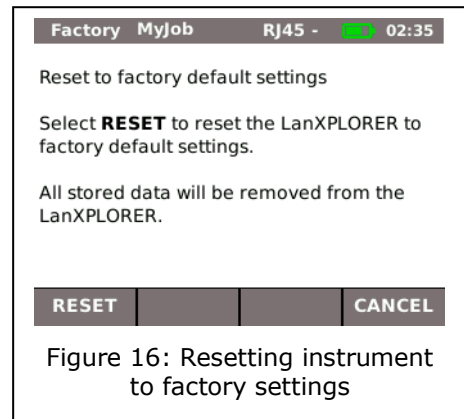

Figure 16: Resetting instrument to factory settings

### 3.3. RJ45

This menu allows configuration of how the RJ45 interface connects to the network.

1. Select **Setup**.
2. Select the menu point "RJ45".



Figure 17: RJ45 Settings

Option	Description
<i>Auto Negotiation</i>	<i>Enabled:</i> Automatic recognition of the network speed. <i>Disabled:</i> It is necessary to set the communication rate and mode manually.
<i>Speed</i> <sup>ii</sup>	Setting the network speed.
<i>Mode</i> <sup>ii</sup>	<i>Full Duplex</i> (all pairs are used for transmitting and receiving). <i>Half Duplex</i> (pairs are used for transmitting or receiving).
<i>Min. Rx Size</i>	Smallest recognised packetsize
<i>MDI</i>	Configuration of the device interface
<i>MAC</i> <sup>ii</sup>	Display of MAC address.

3. Save the entry made with **Apply**. You can exit the menu without saving the changes with **Escape**.

### 3.4. Fibre-optic cable

The SFP version is indicated in this menu.

1. Select **Setup**.
2. Select the menu point "Optical".

### 3.5. Tests

This menu allows settings to be made for the tests.

1. Select **Setup**.
2. Select the menu point "Tests".

#### 3.5.1. Cable tests

This menu allows settings to be made for "wiremap" and "tone generator".

1. Select the menu point "Wiremap".

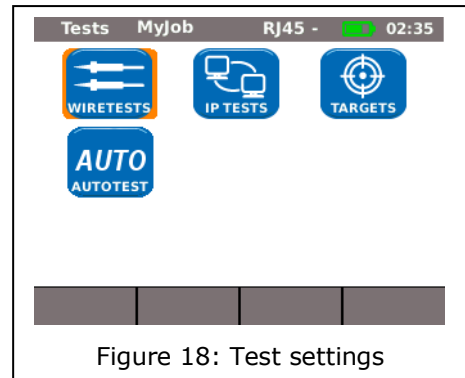

Figure 18: Test settings

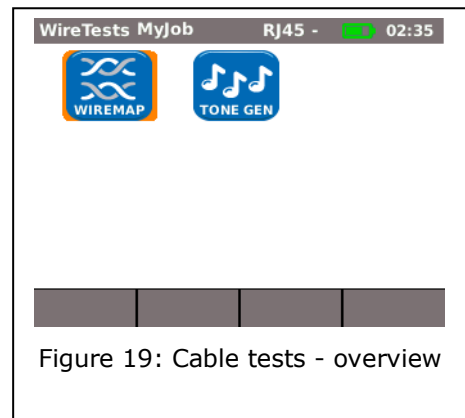

Figure 19: Cable tests - overview

### Setting the wiremap

This menu allows you to set the type of wiring.

1. Select the menu point "Wiremap".

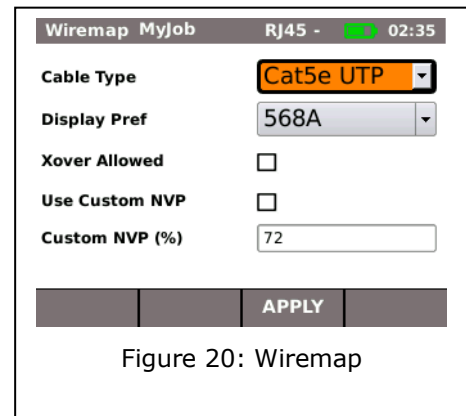

Figure 20: Wiremap

Option	Description
<i>Cable Type</i>	Selection of type of cable.
<i>Display Pref</i>	Selection of wiring schematic.
<i>Xover Allowed</i>	Permit cross-over cables.
<i>Use Custom NVP</i>	Use own NVP value.
<i>Custom NVP<sup>1</sup></i>	Entry of cable-specific NVP value (Nominal Velocity of Propagation) in percent, e.g. 79 for 79%.

2. Select the desired option.
3. Select the desired test parameters or enter the desired information with the alphanumeric keys.
4. Save the entry made with **Apply**. You can exit the menu without saving the changes with **Escape**.

### Setting the tone generator

This menu allows you to set the melody on the tone generator and the pin or pair to be found.

1. Select the menu point "ToneGen".
2. Select the option *Tone* to set the melody.
3. Set the desired option.
4. Select the option *Wire Id* to set the pin or pair to be found.
5. Set the desired option.
6. Save the entry made with **Apply**. You can exit the menu without saving the changes with **Escape**.

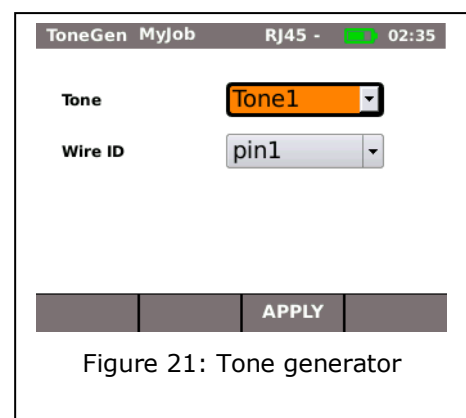

Figure 21: Tone generator

<sup>1</sup> Allows precise length measurement of the pair.

### 3.5.2. Autotest

The **Autotest** options can be set in this menu. You can set the tests to be performed by actuating the **Autotest** button or selecting the "Autotest" menu.

1. Select the menu point "Autotest".
2. Activate or deactivate the option by selecting. An activated option is indicated by a check mark in the box.
3. Save the entry made with **Apply**. You can exit the menu without saving the changes with **Escape**.

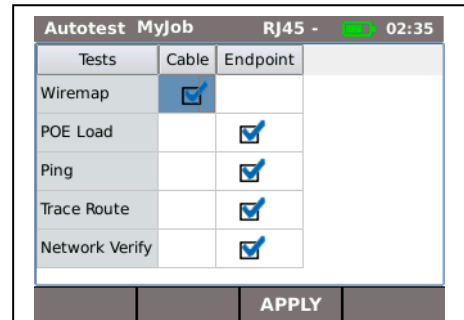

Figure 22: Autotest settings

### 3.5.3. IP Tests

This menu allows settings to be made for the IP test.

1. Select the menu point "IP Tests".

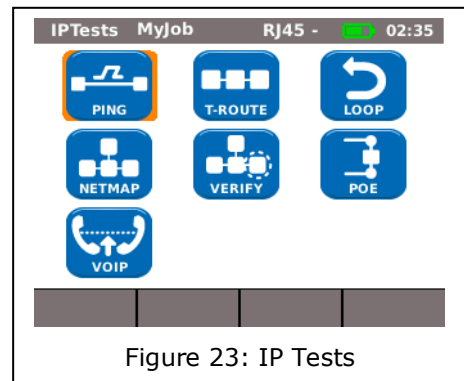

Figure 23: IP Tests

## Ping

This menu allows settings to be made for the ping test.

1. Select the menu point "Ping".



Figure 24: Ping

Option	Description
<i>Target</i>	Select the target address to which the ping is to be sent. Use the option ... to select the list with the target addresses you have saved.
<i>Count</i>	Number of pings sent.
<i>Pause</i>	Period of time between sending pings in milliseconds.
<i>Length</i>	Size of ping package sent.

2. Select the desired option.
3. Enter the desired information with the alphanumeric keys.
4. Save the entry made with **Apply**. You can exit the menu without saving the changes with **Escape**.

## Netmap

This menu allows settings to be made for the netmap test.

Option	Description
<i>Local Network</i>	Scan local network - automatic setting is used.
<i>Custom Network</i>	Scan specific network area.

1. Select the menu point "Netmap".
2. Select the area to be scanned by activating or deactivating the option *Local Network* or *Custom Network*. The option activated is indicated by a check mark in the box.
3. Select the desired option.
4. Select the desired test parameters or enter the desired information with the alphanumeric keys.

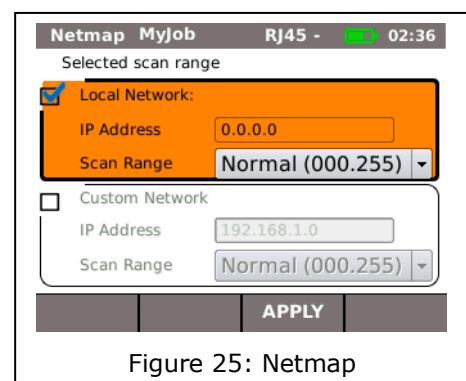

Figure 25: Netmap



5. Save the entry made with **Apply**. You can exit the menu without saving the changes with **Escape**.

### VoIP (Voice over IP)<sup>2</sup>

This menu allows settings to be made for the quality parameter of the VoIP test. The LanXPLOER compares each call with the set quality parameters and evaluates the call.

1. Select the menu point "VoIP".

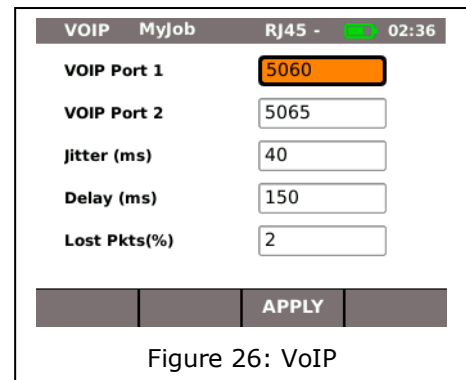

Figure 26: VoIP

Option	Description
<i>VOIP Port 1</i>	Setting the communication port 1
<i>VOIP Port 2</i>	Setting the communication port 2
<i>Jitter (ms)</i>	Limit value for the measuring parameter Jitter
<i>Delay (ms)</i>	Limit value for the measuring parameter Delay
<i>Lost Pkts (%)</i>	Limit value for the measuring parameter of lost packages

2. Select the desired option.
3. Enter the desired information with the alphanumeric keys.
4. Save the entry made with **Apply**. You can exit the menu without saving the changes with **Escape**.

<sup>2</sup> The version of going to press can only be detected by calling up using SIP standard using the LanXPLOER.

### T-Route (Trace Route)

This menu allows settings to be made for the trace route test.

1. Select the menu point "T-Route".



Figure 27: Trace Route

Option	Description
<i>Target</i>	Select the target address to which the ping is to be sent. Use the option ... to select the list with the target addresses you have saved.
<i>Max Hops</i>	Set the maximum number of hops to the target address.
<i>Timeout</i>	Maximum waiting time in seconds.
<i>Type</i>	Set ICMP or UDP.

2. Select the desired option.
3. Select the desired test parameters or enter the desired information with the alphanumeric keys.
4. Save the entry made with **Apply**. You can exit the menu without saving the changes with **Escape**.

### Verify

This menu allows settings to be made for comparing netmaps.

1. Select the menu point "Verify".
2. Set the desired option.
3. Save the entry made with **Apply**. You can exit the menu without saving the changes with **Escape**.

### Loop

This menu allows settings to be made for the loop test.

1. Select the menu point "Loop".
2. Set the desired option.
3. Save the entry made with **Apply**. You can exit the menu without saving the changes with **Escape**.

## PoE

This menu allows settings to be made for the PoE test.

1. Select the menu point "PoE".

Option	Beschreibung
<i>Test Type</i>	PoE: Setup for standard PoE PoE PLUS: Setup for extended PoE PLUS Measurement
<i>Min PoE Power</i>	Threshold for minimum PoE Power
<i>Min PoE Plus Power</i>	Threshold for minimum PoE PLUS Power

2. Select the desired option.
3. Select the desired test parameters or enter the desired information with the alphanumeric keys.
4. Save the entry made with **Apply**. You can exit the menu without saving the changes with **Escape**.

### 3.5.4. Targets

This menu point allows target addresses to be entered and managed for use in the individual tests.

1. Select the menu point "Targets".

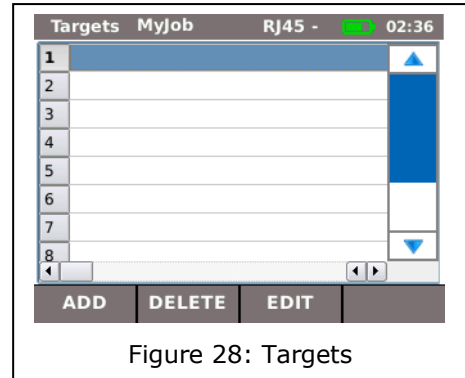

Figure 28: Targets

Softkey	Description
Add	Enter a new target address.
Delete	Delete a target address.
Edit	Change a target address.

#### Adding a target address

2. Select **Add**.
3. Enter the target address with the alphanumeric keys.
4. Save the entry made with **OK**. You can exit the menu without saving the changes with **Cancel** or **Escape**.
5. Save the entry made with **Apply**. You can exit the menu without saving the changes with **Escape**.

#### Deleting a target address

1. Mark the target address to be deleted.
2. Select **Delete**.

#### Changing a target address

3. Mark the target address to be changed.
4. Select edit.
5. Enter the new parameter with the alphanumeric keys.
6. Save the entry made with **Apply**. You can exit the menu without saving the changes with **Escape**.

### 3.6. IP

This menu allows settings to be made for logging onto a network.

1. Select **Setup**.
2. Select the menu point "IP".

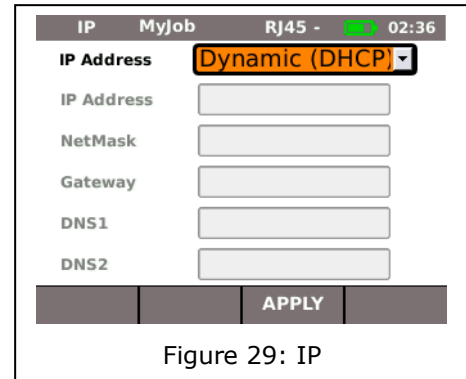

Figure 29: IP

Option	Description
<i>IP Address</i>	<i>Dynamic:</i> Automatic recognition of the network properties. <i>Static:</i> With this option it is necessary to set the network properties manually.
<i>IP Address</i> <sup>3</sup>	Display of IP address.
<i>NetMask</i> <sup>3</sup>	Display of network mask.
<i>Gateway</i> <sup>3</sup>	Gateway setting.
<i>DNS1</i> <sup>3</sup>	DNS1 setting.
<i>DNS2</i> <sup>3</sup>	DNS2 setting.

**NOTE:**

When working with the Static option, request the required information on the IP address, NetMask Gateway and DNS server from your system administrator.

3. Select the option *IP Address* to set *Dynamic* or *Static*.
4. Select the desired option<sup>3</sup>.
5. Enter the desired information with the alphanumeric keys<sup>3</sup>.
6. Save the entry made with **Apply**. You can exit the menu without saving the changes with **Escape**.

<sup>3</sup> This setting is possible only when *IP Address* is set to *Static*.

### 3.7. VLAN

This menu allows settings to be made for testing in virtual LANs.

1. Select **S**etup.
2. Select the menu point "VLAN".

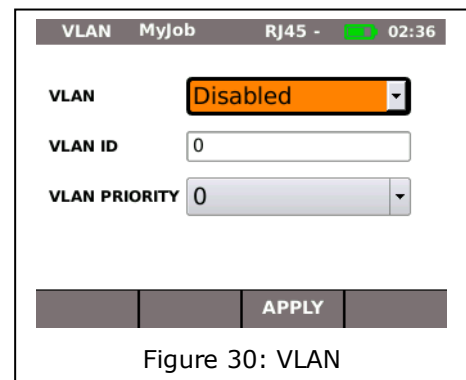

Figure 30: VLAN

Image	Description
<i>VLAN</i>	<i>Disabled</i> : Deactivate virtual network recognition. <i>Enabled</i> : Activate virtual network recognition.
<i>VLAN ID</i>	Manual entry of virtual LAN ID
<i>VLAN PRIORITY</i>	Manual entry of the VLAM Priority from 0 to 7

3. Select the option *VLAN* to set virtual LAN recognition.
4. Select the option *VLAN ID* and enter the desired information with the alphanumeric keys.
5. Save the entry made with **A**pply. You can exit the menu without saving the changes with **E**scape.

### 3.8. WiFi

WiFi networks can be created and managed with this menu.

1. Select the menu point "WiFi" to obtain a list of all WiFi networks created on your LanXPLORER.

#### Connect / disconnect with an existing WiFi network

2. Select a WiFi network from the list that you want to use to connect the instrument.
3. Select  in order to connect the instrument with the WiFi network.
4. Select  in order to disconnect the WiFi network.

#### Creating a new WiFi network

5. Select .
6. Select the menu point "New".
7. Select the desired option.
8. Select the desired test parameters or enter the desired information with the alphanumeric keys.
9. Save the entry made with . You can exit the menu without saving the changes with **Escape**.

#### Changing a WiFi network already present

10. Select a WiFi network from the list that you want to process.
11. Select .
12. Select the menu point "Edit".
13. Select the desired option.
14. Select the desired test parameters or enter the desired information with the alphanumeric keys.
15. Save the entry made with . You can exit the menu without saving the changes with **Escape**.

#### Deleting a WiFi network already present

16. Select a WiFi network from the list that you want to delete.
17. Select .
18. Select the menu point "Delete".

### 3.9. 802.1x

To test networks that use 802.1x security, the tester must be set up as follows:

Import client certificates and root certificates as follows:

- On your PC, create a directory, name it 'certs' and copy the required client and root certificates to that directory.

#### Note

- Root certificates must be of the file type .pem. Client certificates must be of the file type .p12.
- Copy the directory to a USB key and insert it into the USB port.
- From the home screen press the soft key SETUP (F3).
- Select the icon 802.1x. The 802.1x setup screen is displayed.
- Press soft key CERTS (F1) to load the certificates. The loaded certificates will remain until further certificates are loaded or a factory reset is performed.

When entering the 802.1x setup details, scroll to each field, press Enter and select from the drop down menu or look up table as required. Press enter again to return to the 802.1x setup screen. RESET clears all certificate data from the setup screen.

Username and Password fields will display the QWERTY keyboard. When you have entered the Username/Password, press OK to return to the 802.1x setup screen.

The tester's time and date must be correct before 802.1x will work.

- Set the '802.1x' field to Enable.
- Select the required EAP Method from the drop down menu in the 'EAP Method' field. See Notes 1 to 4 below.
- Scroll to the 'Certificate' field and select the required certificate from the look up table.
- Enter a username and password (when required).
- Scroll to the 'Root Cert' field and select the required certificate from the look up table (when required).
- Press the soft key APPLY (F2). You can now connect through the 802.1x port.

#### Notes

1) Completing the fields 'Client Certificate' and 'Certificate Password' is required only when the EAP Method is: EAP-TLS, Any or, the Tunneled Method is TLS.

2) The Tunneled Method and Root Certificate options are enabled only when the EAP Method is EAP-TLS, EAP-PEAP, EAP-TTLS or Any.



3) Use the Root Certificate option only when you want to authenticate the server (RADIUS server).

4) When the EAP Method is EAP-TLS and the Tunneled Method is TLS, the fields Username and Password are optional. For all other types of EAP Method a Username and Password must be entered.

## CHAPTER 4 Test summary

---

This short chapter gives an overview of the tests which can be run with with your LanXPLOER model in the different connection versions.

Test setup	Passive wiring	Active wiring	Inline (only LanXPLOER- Pro)	Fibre-optic cable	WiFi
Test					
Autotest	✓	✓	✓	✓	✓
Wiremap	✓				
ToneGen	✓				
IP		✓	✓	✓	
Mac		✓	✓	✓	
Link		✓	✓	✓	
Ping		✓		✓	✓
Netmap		✓		✓	✓
VoIP			✓		
Trace Route		✓		✓	✓
Network Verify		✓		✓	✓
Loop		✓		✓	
PC Diagnosis			✓		
PoE Load		✓	✓		
Top Ten		✓	✓	✓	
Blink		✓		✓	
Virtual Lan			✓	✓	✓
Scan					✓

The following sections explain the typical test setup for the individual tests with the LanXPLOER.

1. Confirm with the ON button to start the LanXPLOER.
2. Connect the LanXPLOER, if necessary.
3. Select the port to be tested.
4. Select **Detect** or **Scan** to start recognition.

**NOTE:**

The LanXPLOER automatically checks whether power is present on connected cables. If power is recognized, it is indicated by the LanXPLOER. This automatically prevents damage to the tester. In this case it is not possible to run a test. Disconnect the power source from the tester immediately.

### 5.1. Ports

This menu allows you to determine whether a fibre-optic cable, a copper line or a wireless network is to be tested.

1. Select the menu "Ports".
2. Select the desired option.

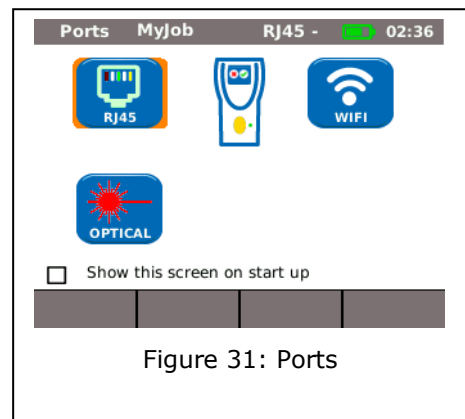

Figure 31: Ports

Option	Description
<i>Optical</i>	Fibre-optic cable
<i>RJ45</i>	Copper cable
<i>WiFi</i>	Wireless network (WLAN)

### 5.2. Passive wiring

This function allows all cables not under power to be tested. If it is not possible to connect cables directly to the interfaces present on the LanXPLOER, the cable can be connected to the LanXPLOER using an adapter.

#### 5.2.1. Testing a passive link without remote / active Remote

When testing a passive link, the instrument tests the connected cable for:

- Length;
- Short-circuit.
  1. Select the menu "Ports" "RJ45".
  2. Disconnect the cable link to be tested from all network components.
  3. Connect cable path earth to the RJ45 network port on the LanXPLOER.
  4. Select **Run** to start recognition of the cable path.

### 5.2.2. Testing a passive link with remote<sup>4</sup> / active Remote<sup>5</sup>

When testing a passive link with remote, the instrument tests the connected cable for:

- Length;
- Short-circuit;
- Pin mixup, split pair;
- Open / broken conductors;
- Error location.

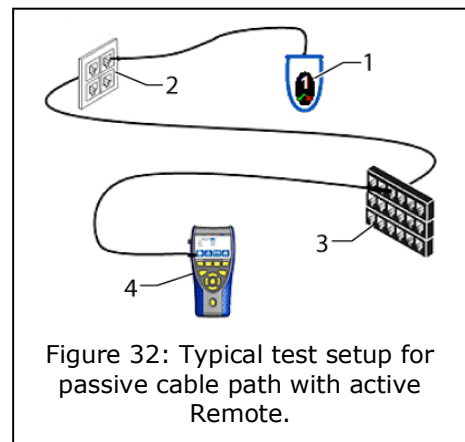

Item	Description
1	Remote / active Remote
2	Wall Outlet
3	Patch Panel
4	LanXPLOER

1. Select the menu "Ports" "RJ45".
2. Disconnect the cable link to be tested from all network components.
3. Connect cable path earth to the RJ45 network port on the LanXPLOER.
4. Connect a remote / active Remote to the other end of the cable path.
5. Select **Run** to start recognition of the cable path.

### 5.3. Active wiring

<sup>4</sup>When testing a passive link with remote, the LanXPLOER can recognise pair errors.

<sup>5</sup> When testing a passive link with smart remote, the LanXPLOER can recognise pin errors.

This function allows all Ethernet-compatible devices to be tested.

1. Select the menu "Ports" "RJ45".
2. Connect a network cable to the Ethernet-compatible device to be tested.
3. Connect the free end of the cable path to the RJ45 network port on the LanXPLOER.

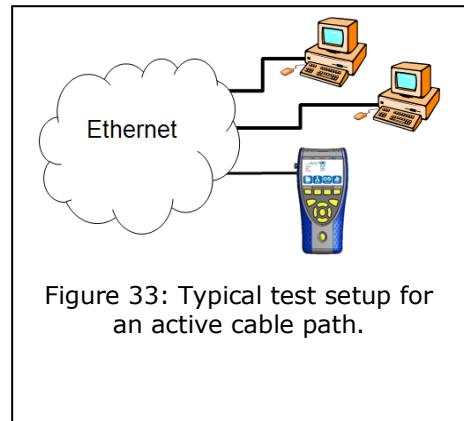

Figure 33: Typical test setup for an active cable path.

4. Select **Detect** to start recognition of the Ethernet-compatible device.

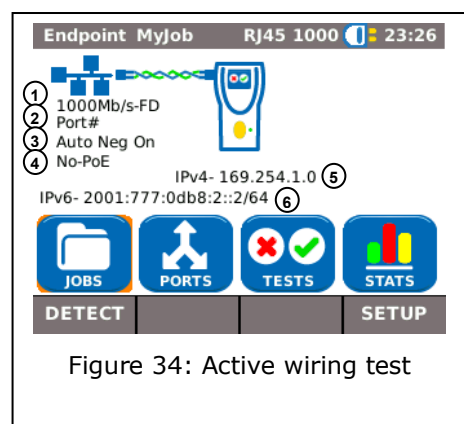

Figure 34: Active wiring test

Item	Description
1	Line Rate and Duplex status (FD - Full Duplex, HD - Half Duplex)
2	Port number of compatible switch
3	Auto Negotiation On/Off
4	Recognition of power over Ethernet. <i>PoE</i> - PoE present. <i>No-PoE</i> - PoE not present.
5	IPv4 address
6	IPv6 address

## 5.4. Inline Test

Connect the LanXPLOER between an Ethernet-compatible device and the network for the inline test. During this test the LanXPLOER measures the traffic between the connected device and the network. If PoE is present, PoE-specific parameters can also be measured.

1. Select the menu "Ports" "RJ45".
2. Connect a network cable to the Ethernet-compatible device to be tested.
3. Connect the free end of the cable path to the RJ45 network port on the LanXPLOER.
4. Connect a network cable to the network.
5. Connect the free end of the cable path to the RJ45 diagnostic port on the LanXPLOER.
5. Select  to start recognition of the Ethernet-compatible device.

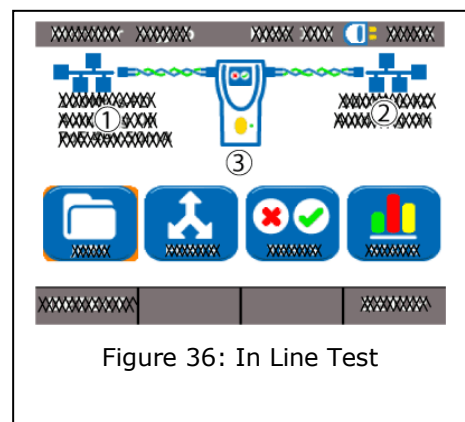
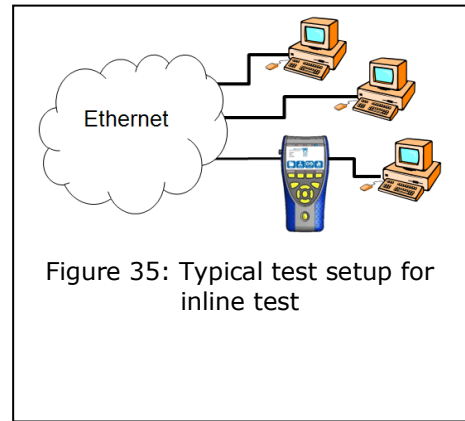

Item	Description
1	Network connection status
2	Connection status of connected Ethernet device.
3	IP address

## 5.5. Fibre-optic cable

This function allows all Ethernet-compatible devices to be tested in the end point mode.

**NOTE:**

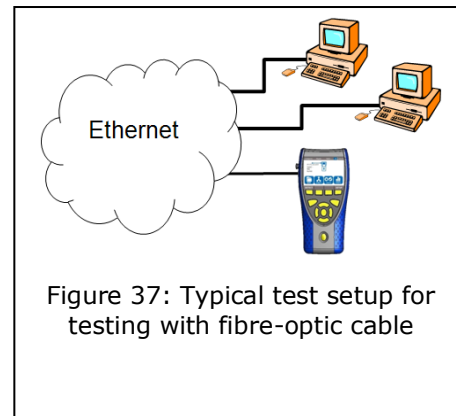
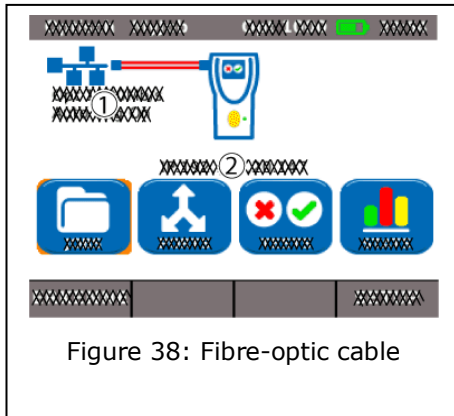

This test function can be used only at an Ethernet transfer rate of 1000 Mbit/s.

1. Select the menu "Ports" "Optical".
2. Connect a fibre-optic cable to the Ethernet-compatible device to be tested.
3. Connect the free end of the cable path to the network port for fibre-optic conductors on the LanXPLOER.
4. Select Detect to start recognition of the Ethernet-compatible device.

Item	Description
1	Transfer rate of connected device.
2	IP address of connected device.

## 5.6. WiFi

With this test the LanXPLOER can be connected with all access points and test wireless networks within reception range. To increase the reception range, plug the supplied high sensitivity antenna into the USB port before following the procedure below. An overview the tests available is given in Table CHAPTER 4.

1. Select the menu "Ports" "WiFi".
2. Select **Scan** to start recognition of the network.

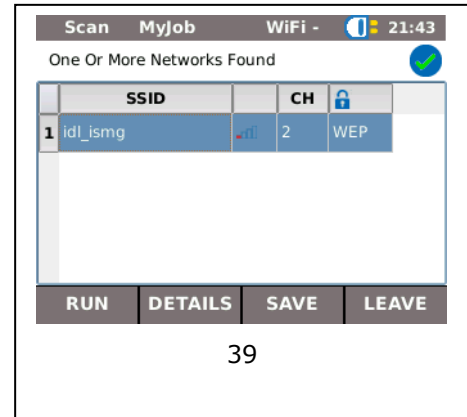

Image	Description
<i>SSID</i>	SSID of access point.
<i>CH</i>	Channel
🔒	Security protocol

3. Select **Run** to start recognition of the network again.
4. Select **Details** to view further information on individual networks.



The availability of individual tests depends on the model version and test setup of the LanXPLOER. An overview the the tests available is given in Table CHAPTER 4.

### 6.1. Test summary

This menu shows all tests possible with the current wiring. In addition it shows which tests have already been performed and the associated pass/fail results.

1. Connect the LanXPLOER in the desired manner.
2. Select the menu point "Tests" on the standby screen.

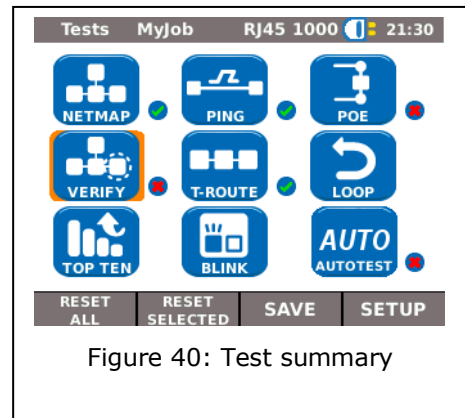

Figure 40: Test summary

Symbol	Overall test results
	Test not performed.
	Test performed and evaluated as passed.
	Test performed and evaluated as failed.

#### 6.1.1. Performing individual tests

1. Select the desired individual test.
2. Perform the test.

The result is stored in the short-term memory and displayed in the test summary.

#### 6.1.2. Resetting test results

1. Select **reset all** in order to delete all individual tests shown in the test summary.

All test results are deleted from the short-term memory.

1. Select **reset selected** in order to reset all marked individual tests that are shown in the test summary.

All test results of the marked individual tests are deleted from the short-term memory.

#### 6.1.3. Saving test results

1. Select **Save** to store all test results in the current job.

All test results are stored in the current job and can be managed there.

## 6.2. Autotest

The autotest feature allows the installation to be checked quickly and easily. After pressing the **AUTOTEST** button, the LanXPLOERER automatically runs the individual tests set.

Selection of the individual tests in the test series depends on the instrument settings and the type of wiring to be tested.

### 6.2.1. Run Autotest

1. Connect the LanXPLOERER in the desired manner.
2. Set the Autotest options (the Autotest option settings are described in Chapter 3.5.2).
3. Select **Run** to start the Autotest.

### 6.2.2. Overall pass/fail result

After conclusion of the test series, the LanXPLOERER displays an overall pass/fail result as well as the individual pass/fail results.

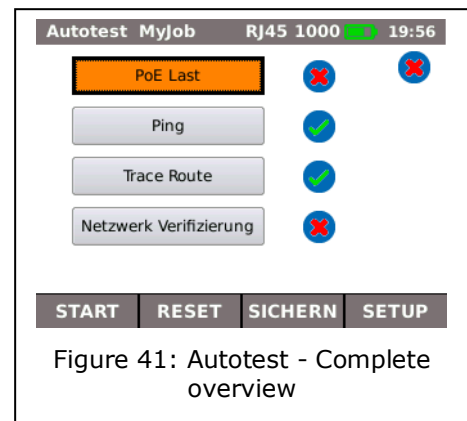

Symbol	Overall Autotest results
	The Autotest is evaluated as passed all total, when all individual tests are passed.
	The Autotest is evaluated as failed all total, when at least one individual test was failed.

You can view the results of the individual tests, save the results or make Autotest settings.

### Display of individual test results

4. Select the desired individual test.
5. Select **More** to view additional details on the specific test results.
6. Press **Escape** to return to the previous screen.

### 6.3. Wiremap test

Short circuits, discontinuities and erroneous circuits can be localised with the aid of the wiremap test. The test results are displayed in the form of a graph to facilitate evaluation.

Any faults indicated in the wiremap test should be remedied before performing further tests, because this would result in errors in the other tests.

The wiremap test guarantees the following minimum thresholds for error recognition (based on four conductor pairs, optional shielding):

- All wiring errors or combined wiring errors are indicated in the wiremap as faults.
- Combinations of up to three interruptions, short-circuits or reversed connections are recognised correctly.
- In the case of discontinuities or short-circuits, the end of the cable, at which the fault occurred, is specified (on Autotest screen for length measurement).
- Split pairs are recognised on the basis of specific patterns of contradictory NEXT values (near-end crosstalk).





#### 6.3.1. Performing Wiremap test

1. Disconnect the cable path to be tested from all network components.
2. Connect the LanXPLOER to one end of the cable path.
3. Connect a remote / active Remote to the other end of the cable path.
4. Select the menu point "Tests" on the standby screen.
5. Select the menu point "Wiremap".
6. Select Run to start the Wiremap test.

#### 6.3.2. Display results

##### Displays on the Active Remote

A flashing LED on the Active Remote indicates the test status:

	LED display	Description
	Red, slowly	The end is near has been detected - Test not performed.
	Fast red:	Fault
	Green, fast	The end is near has been detected - Cable path is okay
	Orange	Incorrect voltage

### Wiremap

Read the wiremap from right to left.

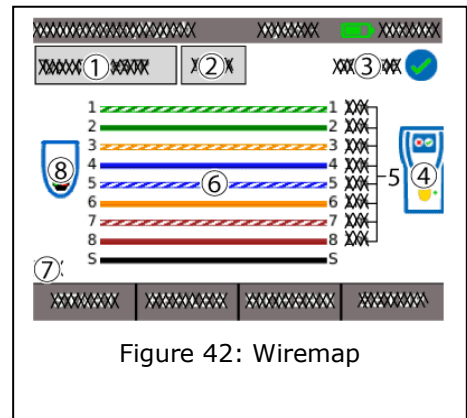

Item	Description
1	Type of cable set
2	Display Preference
3	Wiremap results
4	LanXPLOER
5	Length of pairs
6	Lines
7	Total length
8	Remote / Active Remote (indicated by LED display).

### Examples of errors

Pairs or pins with errors are shown in red.

Item	Description
1	Short-circuit
2	Discontinuities
3	Line crossed

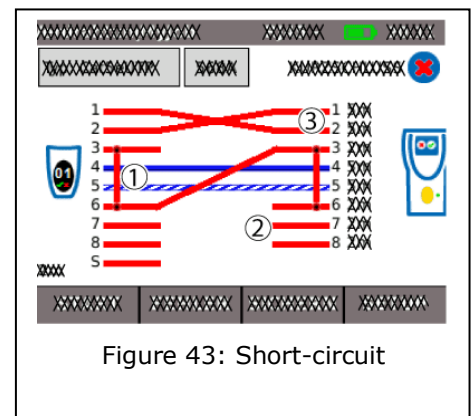

7. Select **More** to view detailed test results.

### 6.4. Testing a passive route without remote / active Remote

The LanXPLOER can generate a low and a high tone and a warbling tone which alternates between the low and high tone at a rate of 2 Hz and can be recognised by the majority of common line testers (e.g. TREND No. 62-164).

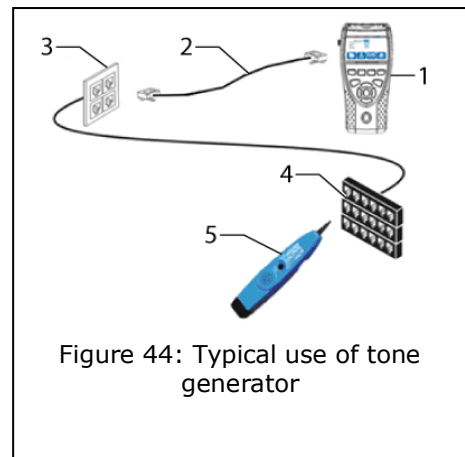

Figure 44: Typical use of tone generator

Item	Description
1	LanXPLOER
2	Patch Cord
3	Wall Outlet
4	Patch Panel
5	Inductive receiver

#### Performing test

1. Connect the free end of the cable path to the RJ45 network port on the LanXPLOER.
2. Select the menu point "Tests" on the standby screen.
3. Select the menu point "ToneGen".
4. Find the open end of the cable path with an inductive receiver (e.g. TREND No. 62-164).

## 6.5. Netmap

This test searches a network for hosts. The LanXPLOER uses the test results to complete an overview of all servers and printers present in the connected network. It also output the total number of all devices found. A maximum of 511 hosts can be detected and displayed.

### 6.5.1. Performing test

1. Select the menu point "Tests" on the standby screen.
2. Select the menu point "Netmap".
3. Select **Run** to start the test.

### 6.5.2. Saving Netmap for comparisons - Verify

The device list can be saved in the instrument and used for comparison with new tests.

1. Select **Save Map** to store the current Netmap.
2. Select the currently saved Netmap.
3. Select **Rename** to edit information.
4. Enter the desired information with the alphanumeric keys.
5. Save the entry made with OK. You can exit the menu without saving the changes with **Cancel** or **Escape**.

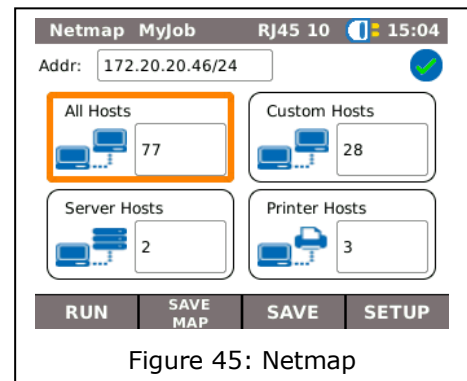

Figure 45: Netmap

### 6.5.3. Display results

It is possible to view the test details on the individual hosts.

- IP address
- MAC address
- Services
- Station name

1. Select the desired option to display a host overview.
2. Mark the host for which you want to view more details.
3. Select the **Details**.

## 6.6. Verify

This test allows a Netmap already saved to be compared with the current Netmap.

### 6.6.1. Performing test

1. Select **Setup** to select the Netmap already saved for comparison.
2. Select the file to be compared and confirm your selection with **Apply**.

**NOTE:**

The name of the file selected for comparison then appears in the menu window at the top right.

3. Select **Run** to start the comparison test.

The LanXPLOER then displays a comparison list for the current Netmap and the saved Netmap.

Image	Description
<i>same</i>	The same host was recognized in the comparison file and the current Netmap.
<i>diff</i>	The host is new in the current Netmap or the host is not present in the current Netmap

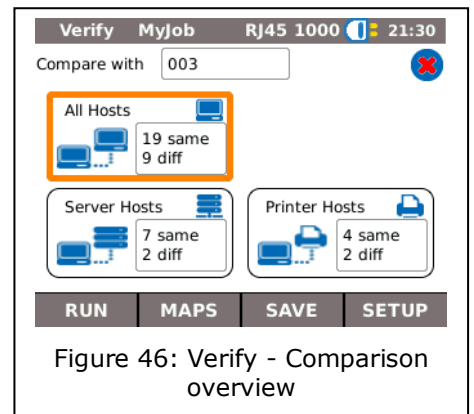

Figure 46: Verify - Comparison overview

### Saving Netmap for comparisons - Verify

The current device list can be saved in the instrument and used for comparison with new tests (see 6.5.2).

## 6.6.2. Display results

### Show comparison list

It is possible to view the test details on the comparison test.

All Hosts;

- New Hosts;
- Missing Hosts.

1. Select the desired option to display a host overview.

### View test details

It is possible to view the test details on the individual hosts.

- IP address;
- MAC address;
- Services;
- Station name.

1. Select the desired option to display a host overview.
2. Mark the host for which you want to view more details.
3. Select the .

## 6.7. Ping

This test checks whether a host is accessible via the network and how long the host requires to reply.

For this purpose the LanXPLOER sends a preset number of pings to multiple target addresses and waits for the replies from the hosts.

### 6.7.1. Performing test

1. Select the menu point "Ping".
2. Select  to define the test parameters.
3. Save the entry made with . You can exit the menu without saving the changes with **Escape**.
4. Select  to start the test.

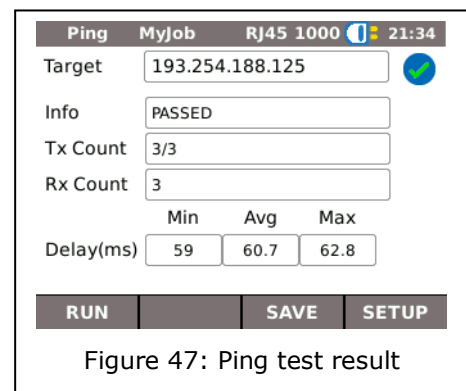



### 6.7.2. Display results

<b>Image</b>	<b>Description</b>
<i>Target</i>	Target address
<i>Info</i>	In Progress - test running Passed - Test passed Unknown host - address not found
<i>Tx Count</i>	Pings sent / total number of pings
<i>Rx Count</i>	Pings received
<i>Delay</i>	Time between sending and receiving pings

## 6.8. Voice over IP (VoIP)

This test allows transfer parameters of VoIP devices to be measured.





For this purpose the LanXPLOERER is switched between the VoIP device and the network in the inline mode and detects incoming calls automatically. From the start of the test, the LanXPLOERER writes call sequentially and compares these with the set quality parameters.

### 6.8.1. Performing test

1. Select the menu point "VoIP".
2. Select Setup to define the quality parameters for the test.
3. Select **Start** to start the test.

The LanXPLOERER now writes the calls sequentially and shows the last 20 calls that have been recorded.

### 6.8.2. Display results

Image	Description
<i>Call</i>	 The call is evaluated as passed.
	 The call is evaluated as fault.
<i>No.</i>	Consecutive number
<i>Start</i>	Call begin
<i>to</i>	Call end
<i>Length</i>	Call period
QOS	Service quality
	 Call corresponds with the quality parameters
	 Call does not correspond with the quality parameters
	 The call had not been accepted.

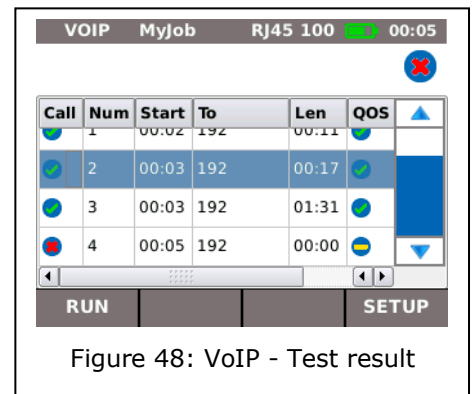

Figure 48: VoIP - Test result

### Have the test details for VoIP-Trace displayed

1. Select the desired call.
2. The VoIP-Trace is displayed by selecting Trace.
3. Press Escape to return to the previous screen.

**Have the test details for the service quality displayed**

1. Select the desired call.
2. Further test details are displayed by selecting QOS.

Image	Description
<i>Jit</i>	Jitter - Call distortion in ms
<i>Dly</i>	Delay - Call delay in ms

3. Press Escape to return to the previous screen.

**6.9. Trace Route**

This test allows display of all hops up to arrival at the target address.

**6.9.1. Performing test**

1. Select the menu point "T-route".
2. Select **Setup** to define the test parameters.
3. Save the entry made with **Apply**. You can exit the menu without saving the changes with **Escape**.
4. Select **Run** to start the test.

**6.9.2. Display results**

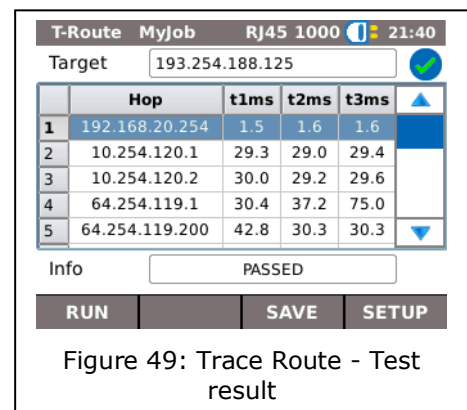

Image	Description
<i>Target</i>	IP target address
<i>Info</i>	Passed - Test passed. Failed - Test failed.
<i>Hop</i>	IP address of hop skipped.
<i>Tx ms</i>	Time required to reach next hop in milliseconds.

## 6.10. Blink

This test allows display of the Ethernet port to which the test cable is connected.

### 6.10.1. Performing test

1. Select the menu point "Blink".
2. Select **Run** to start the test.

On the Ethernet device the corresponding connection point then blinks intermittently.

3. Select **Stop** to terminate the test.

**NOTE:**

Speed and colour of the blinking LED changes periodically and is dependent on the switch type.

## 6.11. Power over Ethernet (PoE)

This test allows the Ethernet power supply for the connected device to be tested.

### 6.11.1. Performing test

1. Select the menu point "PoE".
2. Select **Setup** to define the test parameters.
3. Save the entry made with **Apply**. You can exit the menu without saving the changes with **Escape**.
4. Select **Run** to start the test.

The LanXPLOER then performs the following steps:

- Measurement of incoming voltage;
- Measurement of incoming current;
- Calculation of resulting power;
- Comparison of test results with standard values.

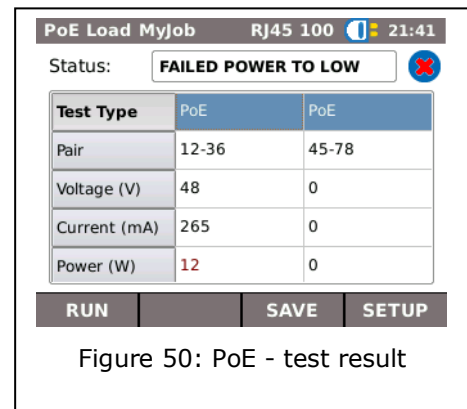

### 6.11.2. Display results

Image	Description
<i>Status</i>	Passed - PoE recognised Failed - PoE not recognised
<i>Test Type</i>	Type of test
<i>Pair</i>	Pair
<i>Voltage</i>	Voltage
<i>Current</i>	Current
<i>Power</i>	Power

## 6.12. Loop

This test allows measurement of the network transfer rate. In this test the LanXPLOER serves as a reply box for a measuring instrument with active layer (up to stage 4) (e.g. Trend Unipro or Trend Multipro).

The LanXPLOER can be set to one of the following types of loops, preset in the instrument:

- Wireline
- Mac
- IP
- UDP

### 6.12.1. Performing test

1. Select **Setup**.
2. Set the type of loop specified by the measuring instrument with active layer.
3. Save the entry made with **Apply**. You can exit the menu without saving the changes with Escape.
4. Select **Run** to start the test.

## 6.13. PC Diagnosis

With this test the LanXPLOER can provide information on the MAC and IP level of the connected PC. Moreover information is output on data transfer (traffic).

1. Select the menu point "PC Diag".
2. Select **Run** to start the test.

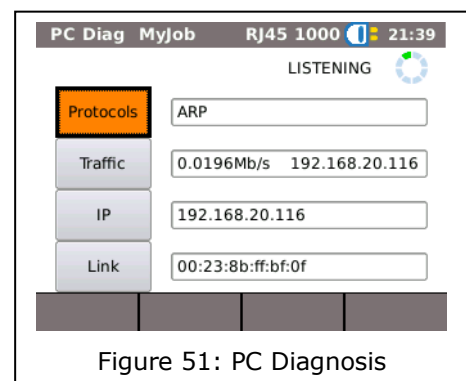

Figure 51: PC Diagnosis

## 6.14. Statistics

The availability of individual statistics depends on the model version and test setup of the LanXPLOER.

Statics are kept automatically on active networks and saved together with the tests performed.

1. Select the menu point "Stats" on the standby screen.
2. Select the desired statistics to be displayed.

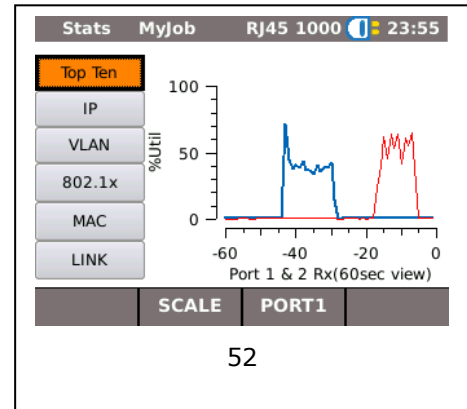

The LanXPLOER can keep the following statistics on active networks.

Image	Description
<i>Top Ten</i>	Display of 10 largest wideband users, error sources and protocols.
<i>IP</i>	Display of device IP login configuration.
<i>VLAN</i>	Display of recognised, active virtual networks presently in use.
<i>MAC</i>	Displays the package statistics in layer 2: <u>More</u> : further package statistics <u>Size</u> : Distribution size of the package
<i>LINK</i>	Display of link information: <u>Port</u> : Detailed information for configuring the port <sup>6</sup> <u>Fault</u> : Detailed fault counter on layer 1 <u>Partner</u> : Possible connecting speeds
<i>802.1x</i>	802.1x Status data listed is: Auth Not Started, Auth Started, Auth Completed Successfully, Auth Failed. Port Status data listed is: Unauthorized, Authorized. Also shown are: EAP Method Used and Key Management Used.

<sup>6</sup> In the fibre-optic conductor mode, lighting power that is additionally received and transmitted is displayed in µW (depending on the SFP version).

## 6.15. WiFi

With this test the LanXPLOER can test wireless networks within reception range. An overview the tests available is given in Table CHAPTER 4.

1. Select the menu "Ports" "WiFi".
2. Select **Scan** to start recognition of the networks.

### 6.15.1. Connecting to a network

3. Select a network with which you want make a connection.
4. Select **Join** in order to connect with the network selected.
5. Confirm the screen message with **OK** if you want to configure the network.

The device detects and sets the coding type automatically.

6. Select the menu point *Code*.
7. Enter the network code with the alphanumeric keys.
8. Save the entry made with **OK**. You can exit the menu without saving the changes with **Cancel** or **Escape**.
9. Save the entry made with **Apply**. You can exit the menu without saving the changes with **Escape**.
10. In the option *Code type*, set ASCII or HEX.

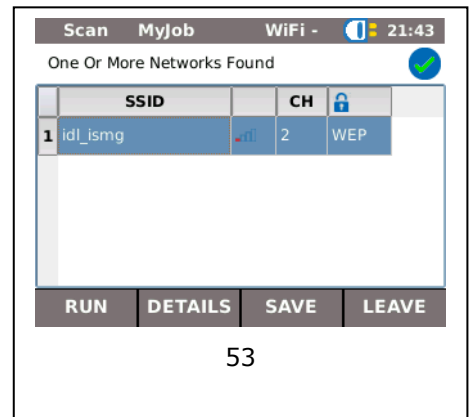

#### NOTE:

The information required for setting the network has to be requested from your system administrator. If a Default Accesspoint has been saved in the LanXPLOER, when activated, the device connects to the WiFi function automatically using this Accesspoint.

11. Select **Apply** in order to take over the settings.
12. Select **Join** in order to connect with the network.
13. Confirm the screen message with OK.

The SSID of the network with which you are connected will be displayed in bold and underlined.

14. Select **Save** to store all test results in the current job.
15. Select **Details** to view further information on individual networks.

### 6.15.2. Performing tests

The name of the IP address and of the network is shown on the standby screen with which the device has been connected.

1. Select the menu point "Tests" on the standby screen.
6. Select the desired individual test.
7. Perform the test.

The result is stored in the short-term memory and displayed in the test summary.

## 7.1. Safety precautions



### ATTENTION!

Never look directly into the socket of the SFP module, at connector surfaces, open fibre ends or into connectors. The danger exists that light in the non-visible spectrum could be emitted and permanently damage your eyes.

If you are not sure whether the device is switched on or if the fibre is conducting light, always be on the safe side and assume that light could be emitted.

Treat open fibres properly; fibre splinters can pose an injury hazard.

Protect your eyes when working on open fibres; fibre splinters can cause permanent eye damage.

Never leave fibre remnants lying around open and never dispose of such remnants loose with domestic wastes; the fibre splinters pose an injury hazard.

Before cleaning SFP modules, we recommend removing them from the instrument. This ensures that light cannot be admitted inadvertently during the cleaning process.



### CAUTION!

Observe the maximum measuring range when connecting SFP modules to a light conducting link (see specifications for individual SFP modules). Exceeding this distance can lead to damage to the SFP modules.

## 7.2. Instructions for cleaning SFP modules and patch cables

### NOTE:

Before connecting the measuring cables to the SFP modules, ensure that the connectors on the measuring cables are clean.

Clean the ferrule on the SFP sockets with dry, lint-free, non-scratching materials.

The connectors can be cleaned with suitable fibre-glass cleaning cloths or cleaning swabs. TREND recommends cleaning set #1219-00-1621 for care of the SFP modules and patch cables.



## CHAPTER 8 LanXPLORER Firmware Update

---

The LanXPLORER firmware should be updated at regular intervals. The latest firmware update can be downloaded from the TREND NETWORKS Internet site.

If you register for the **Newsletter** on the TREND NETWORKS Internet site, you will be notified of new downloads automatically.

The LanXPLORER firmware can be updated using as USB storage device.

**NOTE:**

Before updating the firmware, make a backup of the test data on the LanXPLORER.

When updating the firmware, power should be supplied to the LanXPLORER using the charger/power pack or ensure that the rechargeable batteries are fully charged.

Data export and data import is accomplished exclusively to/from a USB storage device connected to the LanXPLORER.

1. Store the firmware update on an empty USB storage device.
2. Plug the USB storage device into the USB interface on the LanXPLORER.
3. Switch on the LanXPLORER.
4. Ensure that the rechargeable batteries in the LanXPLORER are charged or connect the LanXPLORER to mains power.
5. Select the menu point **Setup**.
6. Select the menu point "System".
7. Select the menu point "Update".
8. **Update** the software. You can exit the menu without saving the changes with **Cancel** or **Escape**.
9. Select "Confirm" to start the update.
10. Wait until the update has concluded and the main menu appears on the LanXPLORER display after restarting.
11. Remove the USB storage device.

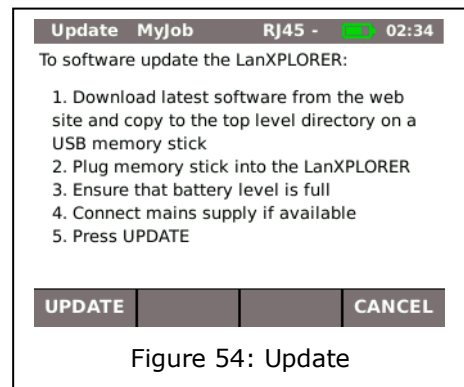

Figure 54: Update

**NOTE:**

Depending on the update, the LanXPLORER will re-start automatically or requires a manual re-start.

## CHAPTER 9

### Spare parts - Socket inserts

---

The LanXPLOERER provides the possibility of replacing damaged or worn sockets with the RJ45 socket insert set (TREND 150058).

#### Equipment included

Quantity	Description
1	Tool
10	Replacement insert

#### Changing the socket insert

1. Switch the LanXPLOERER off.
2. Remove cables.
3. Carefully push the tool STRAIGHT into the socket. BE CAREFUL - DO NOT MOVE THE TOOL VERTICALLY!



4. Keeping the tool STRAIGHT firmly pull the insert out from the socket.



5. Using fingers replace a new insert STRAIGHT into the socket and secure in place by firmly pushing it home.

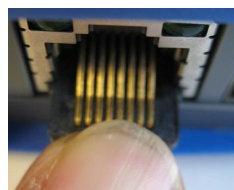





**TREND NETWORKS**

TREND NETWORKS  
Stokenchurch House, Oxford Road,  
Stokenchurch,  
High Wycombe, Bucks, HP14 3SX, UK.  
[www.trend-networks.com](http://www.trend-networks.com)